

Carrier Frame with Central Water Supply

Product Information 2019-10



Carrier Frame with Central Water Supply

- Carrier frame on castors for 2 up to 16 temperature control units Thermo-5, housing size 1 (other sizes on request)
- Water distribution for cooling water (CW) inlet and outlet including quick release shut-off couplings DN13
- Water distribution for separate system water (SW) inlet and outlet including quick release shut-off couplings DN9 (optional)
- Central water supply inlet and outlet with shut-off valves and inlet filter
- Base plate on each level with positioning slots for the units
- Extra space allotted for flow meter Flow-5 (model: unit attachment)

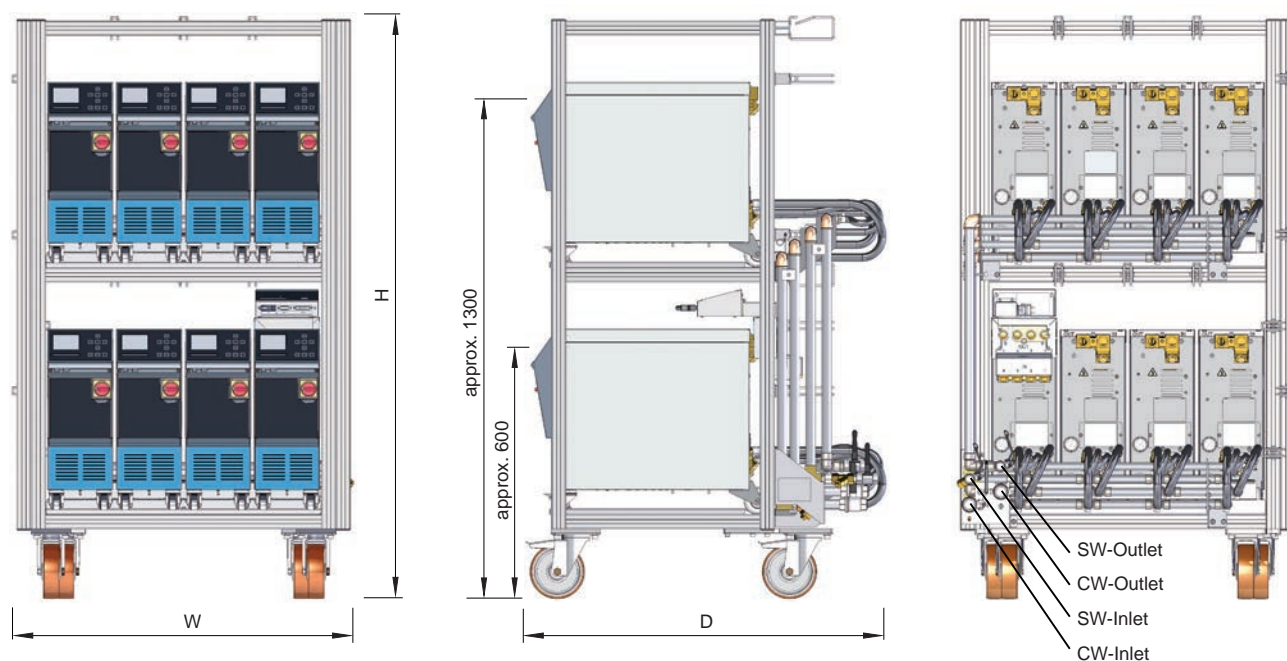

Description	Type	Level(s) Units/Level		Height H mm	Width W mm	Depth D mm	O/ID
		Connection					
		CW	SW				
Carrier frame with castors incl.: - cooling water distribution (CW) Resistance: 10 bar, 100 °C	HB-RA1-2	G¾	-	875	500	930	T25623
	HB-RA1-3	G¾	-	875	690	930	T24923
	HB-RA1-4	G¾	-	875	880	930	T25624
	HB-RA2-2	G¾	-	1550	540	930	T25606
	HB-RA2-3	G¾	-	1550	730	930	T25607
	HB-RA2-4	G¾	-	1610	920	980	T25608
	HB-RA2-5	G¾	-	1610	1110	980	T25609
	HB-RA2-6	G1	-	1610	1310	1060	T25610
Carrier frame with castors incl.: - cooling water distribution (CW) - system water distribution (SW) Resistance: 10 bar, 100 °C	HB-RA2-7	G1	-	1680	1500	1060	T25611
	HB-RA2-8	G1	-	1680	1690	1060	T25612
	HB-RA1-2	G¾	G½	875	500	930	T25625
	HB-RA1-3	G¾	G½	875	690	930	T25626
	HB-RA1-4	G¾	G½	875	880	930	T25627
	HB-RA2-2	G¾	G½	1550	540	930	T25613
	HB-RA2-3	G¾	G½	1550	730	930	T25614
	HB-RA2-4	G¾	G½	1610	920	980	T25615
	HB-RA2-5	G¾	G½	1610	1110	980	T25616
	HB-RA2-6	G1	G¾	1610	1310	1060	T25617
	HB-RA2-7	G1	G¾	1680	1500	1060	T25618
	HB-RA2-8	G1	G¾	1680	1690	1060	T25619
Power distribution with 4 CEKON-sockets 16 A, 3LNPE with individual circuit breakers and central power cord with CEKON-plug 63 A, 3LNPE				460	260	195	T25621
Pivoting base for control module							T25620

Ordering example: HB-RA2-4 (O/ID T25615)